

Features

- Mirror cabinet without light
- Mirrored interior with adjustable glass shelves
- Includes adjustable makeup mirror with light
- Includes outlet
- Includes a magnet on the bridge
- Includes installation hardware for recess mounting
- Can be recessed or surface mounted (surface mounting kit required)

Construction

- Grey aluminum body and door frame
- 3 mirror design – rear of cabinet and both sides of door
- Concealed finger pull-door edge
- Three pieces self-closing hinges for each door ,
side door open 155 degrees, middle door open 90 degrees
- Adjustable shelving at 2 1/3" (60 mm) increments
- Single field wire into electrical shelf - Front access serviceability

Codes / Standards Applicable

Electric Option Models are ETL certified to:

- UL 962
- CSA Standard C22.2 No. 68

Dimensions

- Height: 36" (913mm)
- Width: 40" (1016 mm)
- Depth: 5" (127 mm)
1" (25 mm) Project from wall when recessed

Installation Options

- Recessed Mount - Rough Opening - 35-1/2" H x 39-1/2" W x 4" D
(901mm H x 1003mm W x 102mm D)
- Surface Mount - Surface Mount Kit is included

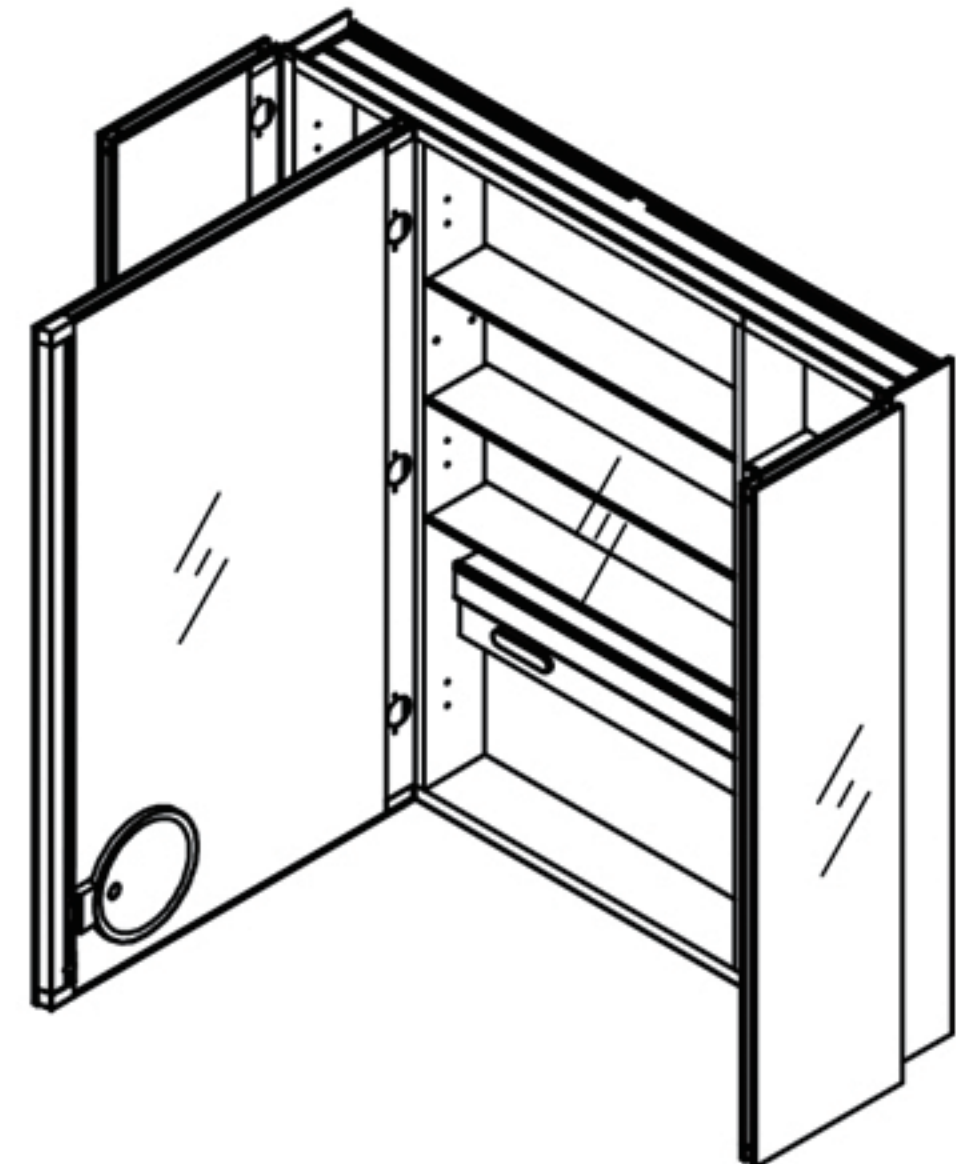
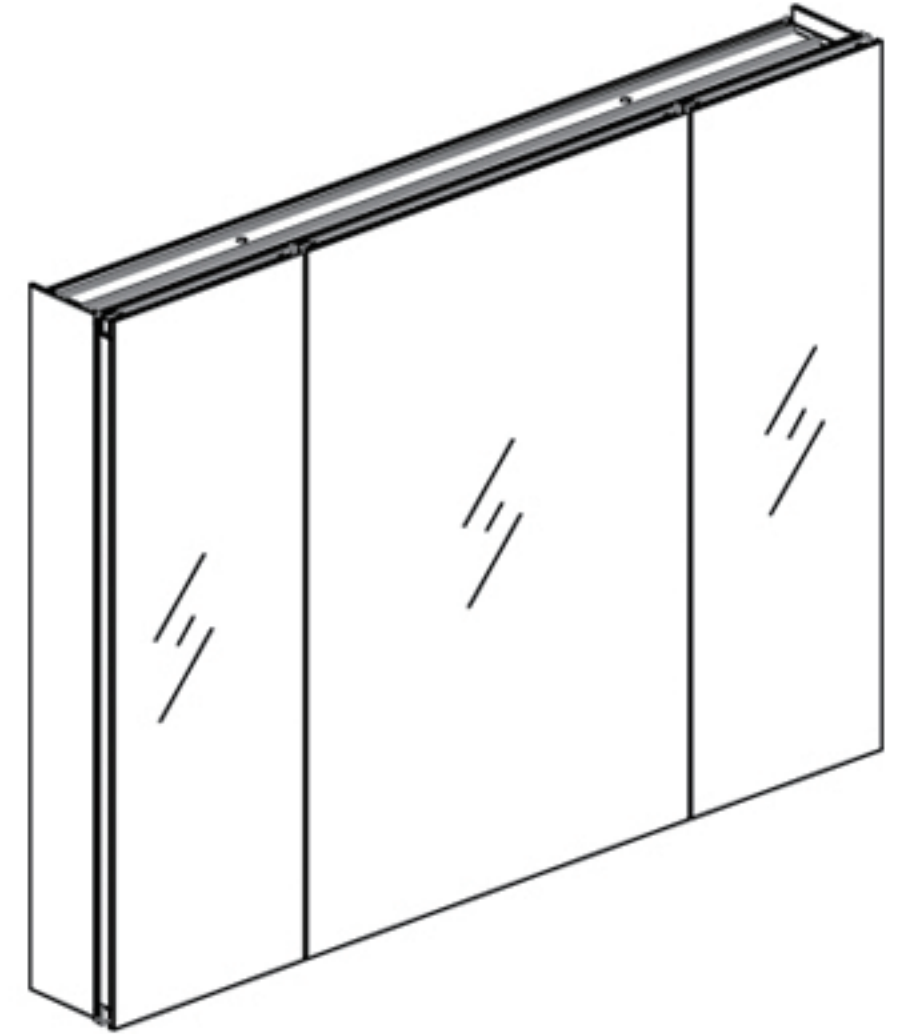

Electrical System

- INPUT : 110VAC
- OUTPUT : 110VAC
- Field wire location as shown in drawing
- 1/2" conduit (Ø 7/8" actual) electrical knockout location shown below
- Included field wire cable clamp
- Circuit Diagram

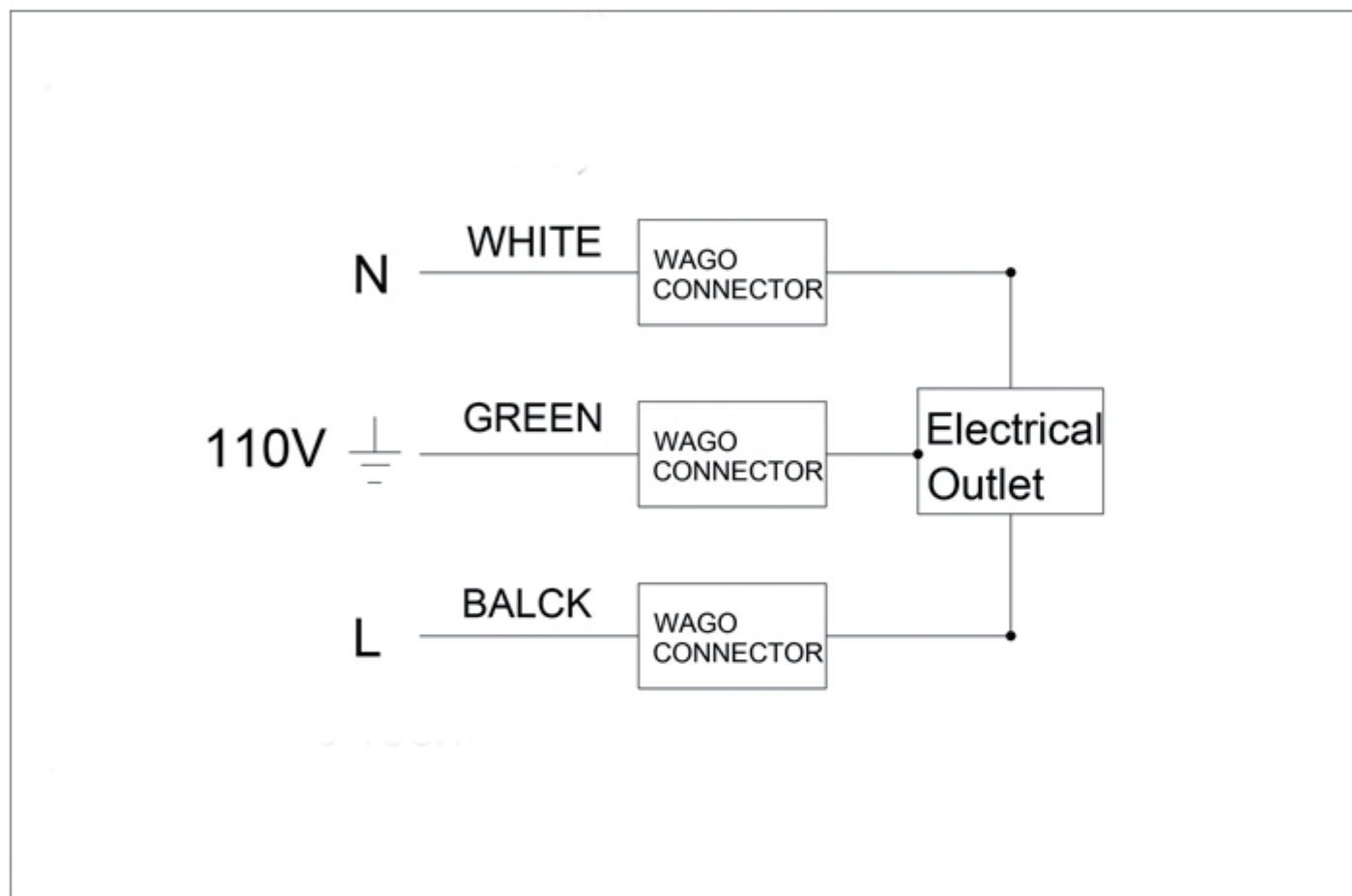

Circuit Diagram

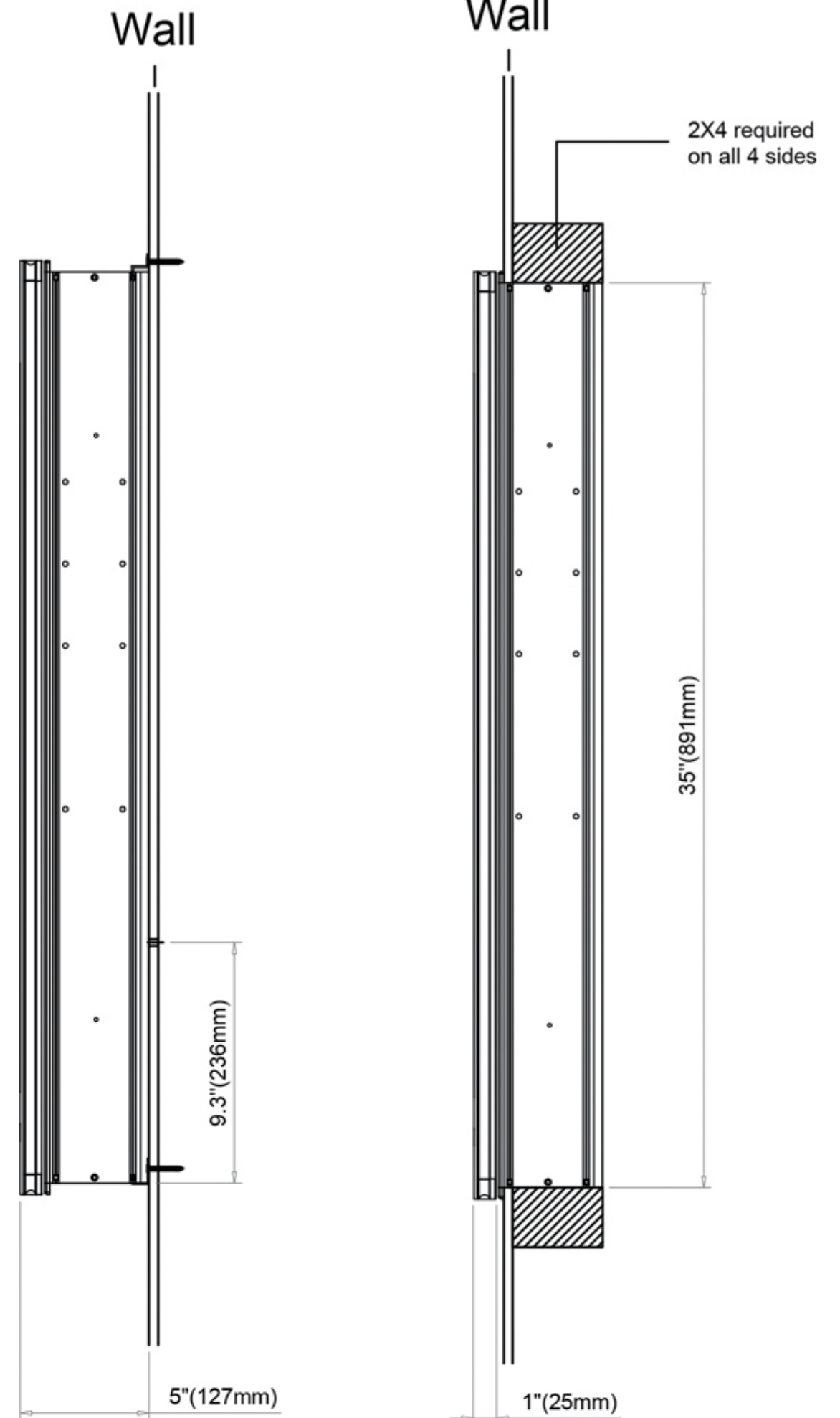

Surface Mount

Recessed Mount

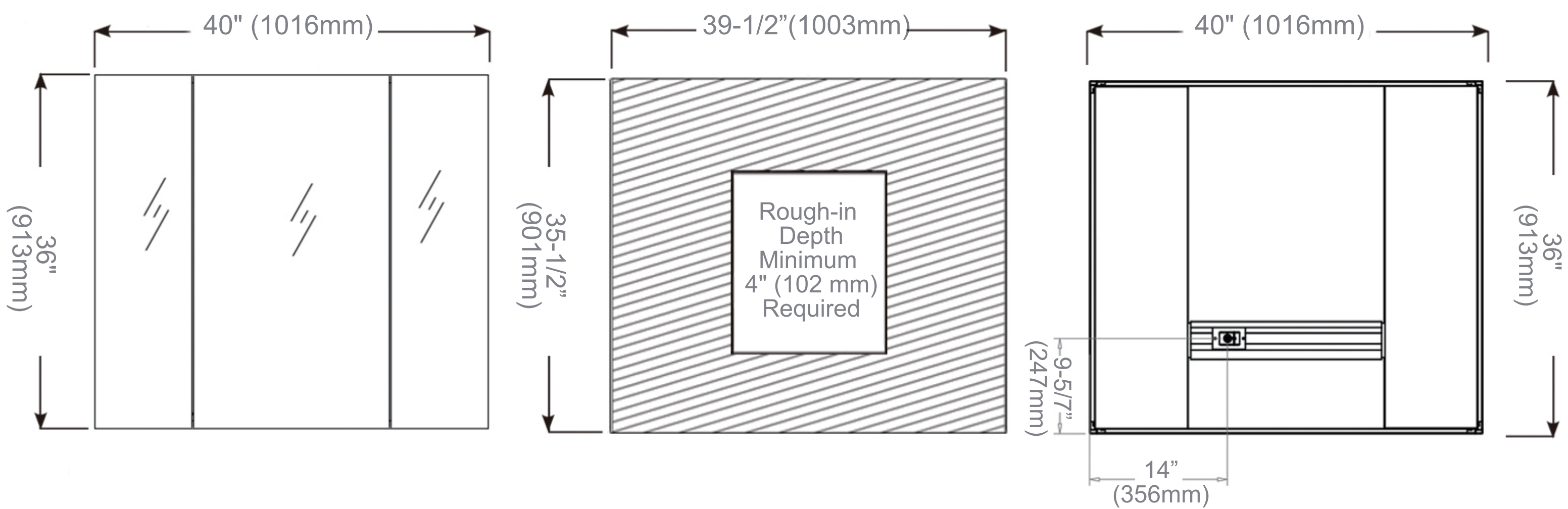

Cabinet Dimensions

Rough-in Dimensions

Back of Cabinet - Wire Access Location